

EZ-8.4SS (AIR STRIPPER ONLY)

FOR MORE SPECIFICATIONS CLICK ON:

http://www.qedenv.com/Products/Airstrippers_VOC_Removal/Air_Stripper_Specifications/

NOT TO SCALE
NOT FOR CONSTRUCTION, FOR REFERENCE ONLY

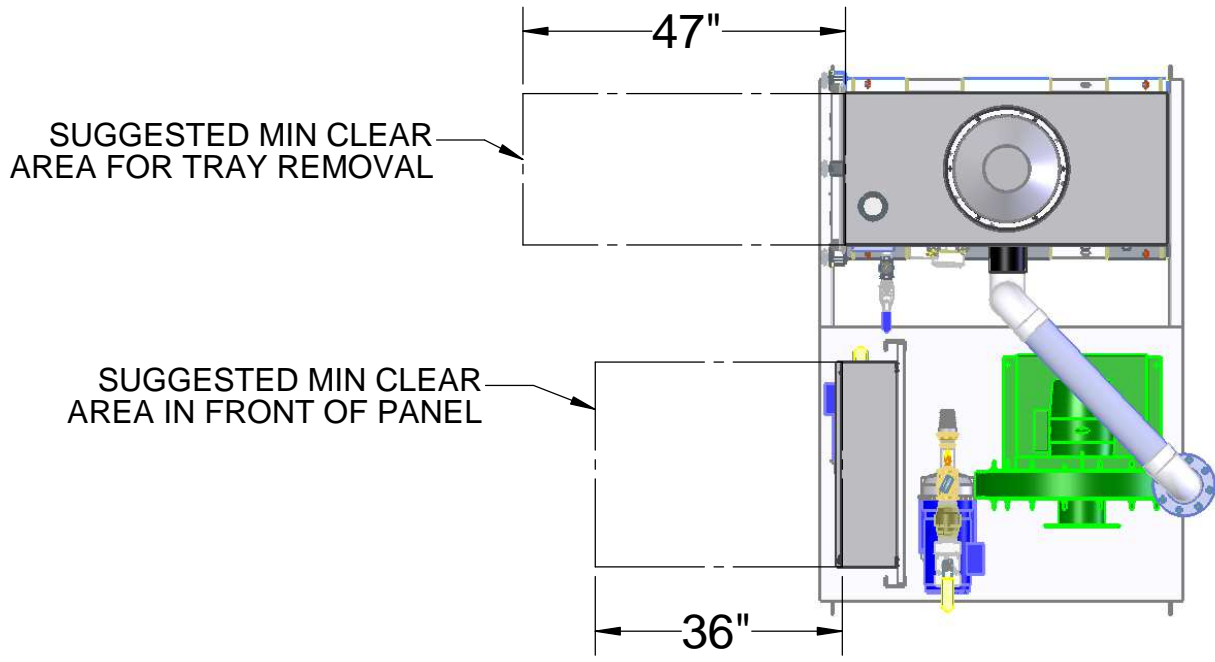

PLAN VIEW

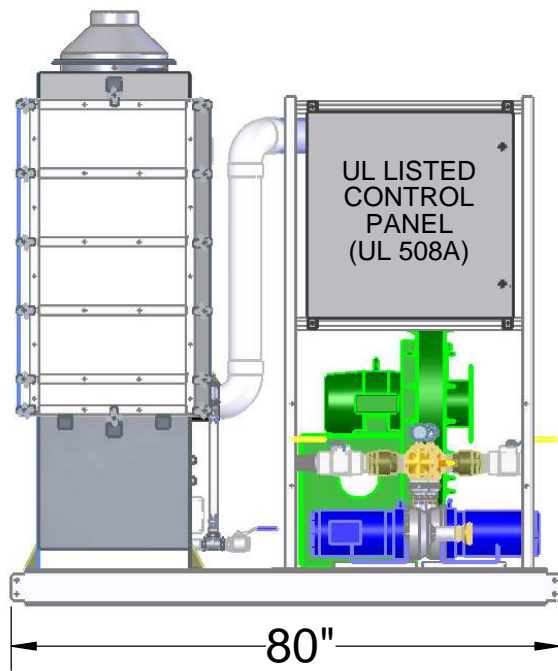

FRONT VIEW

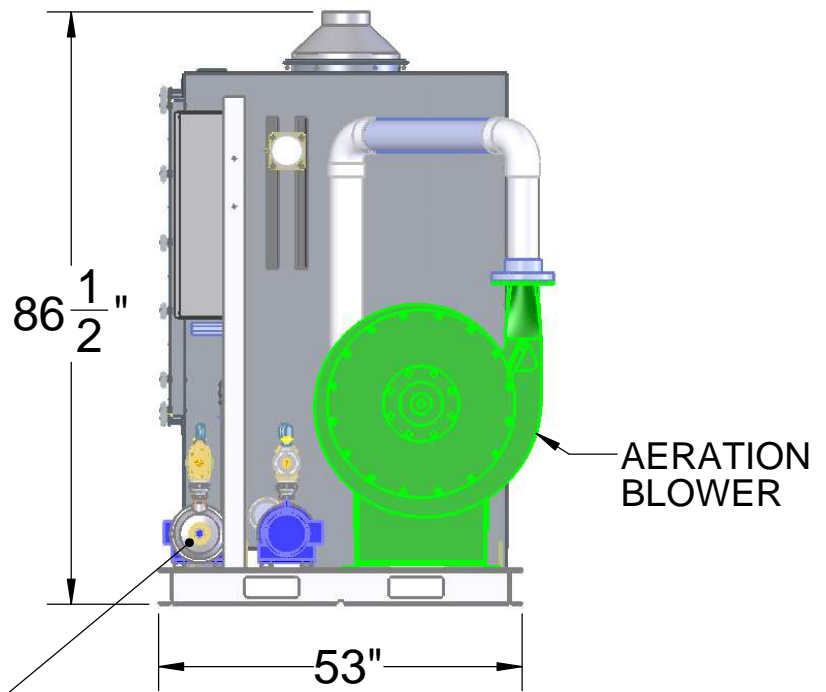

WATER INLET AND DISCHARGE PUMPS
(TYPICALLY 2" NPT CONNECTIONS)

SIDE VIEW

EZ-8.4SS

EXAMPLE OF A SKID SYSTEM WITH CONTROL PANEL, PUMPS, AND BLOWER
CONTACT QED FOR INFORMATION ON ALL OPTIONS.

NOT TO SCALE

NOT FOR CONSTRUCTION, FOR REFERENCE ONLY